

FEATURES

- **Sample Rate: 100ksps**
- **8-Channel Multiplexer with $\pm 25V$ Protection**
- **Single 5V Supply**
- **Software-Programmable Input Ranges:**
 - **0V to 5V, 0V to 10V, $\pm 5V$ or $\pm 10V$**
 - **Single-Ended or Differential**
- **$\pm 3LSB$ INL for the LTC1859, $\pm 1.5LSB$ INL for the LTC1858, $\pm 1LSB$ INL for the LTC1857**
- **Power Dissipation: 40mW (Typ)**
- **SPI/MICROWIRE™ Compatible Serial I/O**
- **Power Shutdown: Nap and Sleep**
- **Signal-to-Noise Ratio: 87dB (Typ) for the LTC1859**
- **Operates with Internal or External Reference**
- **Internal Synchronized Clock**
- **28-Pin SSOP Package**

APPLICATIONS

- Industrial Process Control
- Multiplexed Data Acquisition Systems
- High Speed Data Acquisition for PCs
- Digital Signal Processing

DESCRIPTION

The **LTC®1857/LTC1858/LTC1859** are 8-channel, low power, 12-/14-/16-bit, 100ksps, analog-to-digital converters (ADCs). These SoftSpan™ ADCs can be software-programmed for 0V to 5V, 0V to 10V, $\pm 5V$ or $\pm 10V$ input spans and operate from a single 5V supply. The 8-channel multiplexer can be programmed for single-ended inputs or pairs of differential inputs or combinations of both. In addition, all channels are fault protected to $\pm 25V$. A fault condition on any channel will not affect the conversion result of the selected channel.

An onboard high performance sample-and-hold and precision reference minimize external components. The low 40mW power dissipation is made even more attractive with two user selectable power shutdown modes. DC specifications include $\pm 3LSB$ INL for the LTC1859, $\pm 1.5LSB$ INL for the LTC1858 and $\pm 1LSB$ for the LTC1857.

The internal clock is trimmed for 5 μs maximum conversion time and the sampling rate is guaranteed at 100ksps. A separate convert start input and data ready signal (\overline{BUSY}) ease connections to FIFOs, DSPs and microprocessors.

LT, LT, LTC and LTM are registered trademarks of Linear Technology Corporation. SoftSpan is a trademark of Linear Technology Corporation. All other trademarks are the property of their respective owners.

TYPICAL APPLICATION

100kHz, 12-Bit/14-Bit/16-Bit Sampling ADC

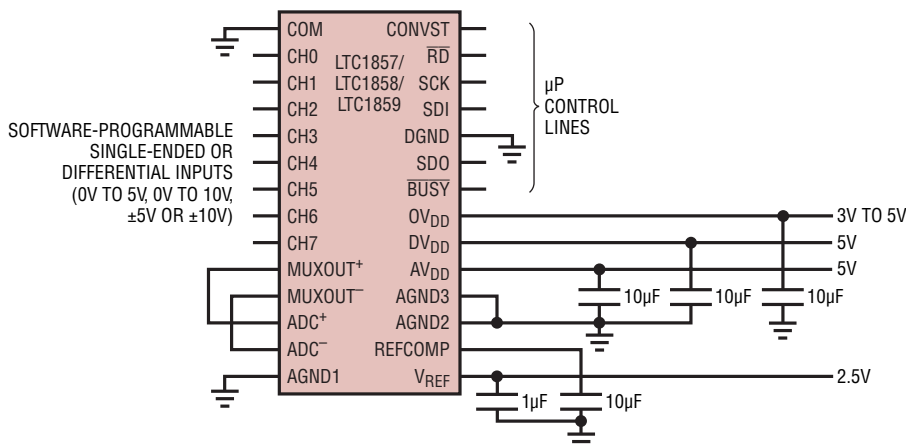

LTC1859 Typical INL Curve

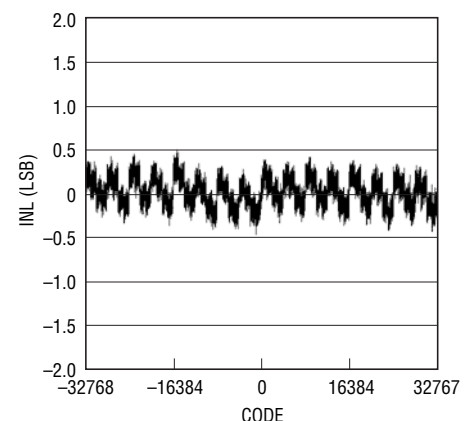

185789fb

LTC1857/LTC1858/LTC1859

ABSOLUTE MAXIMUM RATINGS

(Note 1)

Supply Voltage ($OV_{DD} = DV_{DD} = AV_{DD} = V_{DD}$).....	6V
Ground Voltage Difference DGND, AGND1, AGND2, AGND3	$\pm 0.3V$
Analog Input Voltage ADC ⁺ , ADC ⁻ (Note 3)	(AGND1 – 0.3V) to (AV _{DD} + 0.3V)
CHO-CH7, COM	$\pm 25V$
Digital Input Voltage (Note 4).....	(DGND – 0.3V) to 10V
Digital Output Voltage ..(DGND – 0.3V) to (DV _{DD} + 0.3V)	
Power Dissipation	500mW
Operating Temperature Range LTC1857C/LTC1858C/LTC1859C	0°C to 70°C
LTC1857I/LTC1858I/LTC1859I.....	–40°C to 85°C
Storage Temperature Range.....	–65°C to 150°C
Lead Temperature (Soldering, 10 sec)	300°C

PIN CONFIGURATION

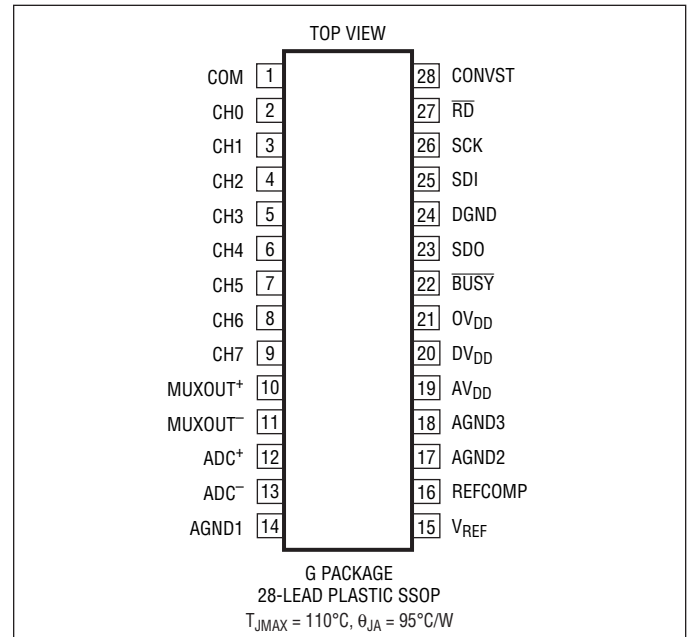

ORDER INFORMATION

LEAD FREE FINISH	TAPE AND REEL	PART MARKING	PACKAGE DESCRIPTION	TEMPERATURE RANGE
LTC1857CG#PBF	LTC1857CG#TRPBF	LTC1857CG	28-Lead Plastic SSOP	0°C to 70°C
LTC1857IG#PBF	LTC1857IG#TRPBF	LTC1857IG	28-Lead Plastic SSOP	–40°C to 85°C
LTC1858CG#PBF	LTC1858CG#TRPBF	LTC1858CG	28-Lead Plastic SSOP	0°C to 70°C
LTC1858IG#PBF	LTC1858IG#TRPBF	LTC1858IG	28-Lead Plastic SSOP	–40°C to 85°C
LTC1859CG#PBF	LTC1859CG#TRPBF	LTC1859CG	28-Lead Plastic SSOP	0°C to 70°C
LTC1859IG#PBF	LTC1859IG#TRPBF	LTC1859IG	28-Lead Plastic SSOP	–40°C to 85°C

Consult LTC Marketing for parts specified with wider operating temperature ranges.

For more information on lead free part marking, go to: <http://www.linear.com/leadfree/>

For more information on tape and reel specifications, go to: <http://www.linear.com/tapeand reel/>

CONVERTER AND MULTIPLEXER CHARACTERISTICS

The ● denotes the specifications which apply over the full operating temperature range, otherwise specifications are at $T_A = 25^\circ\text{C}$. MUXOUT connected to ADC inputs. (Notes 5, 6)

PARAMETER	CONDITIONS	LTC1857			LTC1858			LTC1859			UNITS
		MIN	TYP	MAX	MIN	TYP	MAX	MIN	TYP	MAX	
Resolution	●	12			14			16			Bits
No Missing Codes	●	12			14			15			Bits
Transition Noise			0.06			0.26			1		LSB _{RMS}
Integral Linearity Error	(Notes 7, 15)	●		±1		±1.5			±3		LSB
Differential Linearity Error	(Note 15)	●	-1	1	-1	1.5	-2		4		LSB
Bipolar Zero Error	(Note 8)	●		±9		±17			±28		LSB
Bipolar Zero Error Drift			±0.1		±0.1			±0.1			ppm/°C
Bipolar Zero Error Match				±4		±6			±10		LSB
Unipolar Zero Error	(Note 8)	●		±6		±15			±25		LSB
Unipolar Zero Error Drift			±1		±1			±1			ppm/°C
Unipolar Zero Error Match				±1.2		±2			±8		LSB
Bipolar Full-Scale Error	External Reference (Note 11) Internal Reference (Note 11)	●		±0.35 ±0.45		±0.15 ±0.4			±0.1 ±0.4		% %
Bipolar Full-Scale Error Drift	External Reference Internal Reference		±2.5 ±7		±2.5 ±7			±2.5 ±7			ppm/°C ppm/°C
Bipolar Full-Scale Error Match				±5		±10			±15		LSB
Unipolar Full-Scale Error	External Reference (Note 11) Internal Reference (Note 11)	●		±0.45 ±0.75		±0.25 ±0.85			±0.2 ±0.75		% %
Unipolar Full-Scale Error Drift	External Reference Internal Reference		±2.5 ±7		±2.5 ±7			±2.5 ±7			ppm/°C ppm/°C
Unipolar Full-Scale Error Match				±5		±12			±15		LSB
Input Common Mode Range	Unipolar Mode Bipolar Mode	● ●	0 to 10 ±10		0 to 10 ±10			0 to 10 ±10			V V
Input Common Mode Rejection Ratio			96		96			96			dB

ANALOG INPUT

The ● denotes the specifications which apply over the full operating temperature range, otherwise specifications are at $T_A = 25^\circ\text{C}$. (Note 5)

PARAMETER	CONDITIONS	MIN	TYP	MAX	UNITS
Analog Input Range	CH0 to CH7, COM		0 to 5, 0 to 10 ±5, ±10		V V
	ADC ⁺ , ADC ⁻ (Note 3)		0 to 2.048		V
			0 to 4.096		V
			ADC ⁻ ±1.024		V
		ADC ⁻ ±2.048		V	
Impedance	CH0 to CH7, COM				
	Unipolar		42		kΩ
	Bipolar		31		kΩ
	MUXOUT ⁺ , MUXOUT ⁻				
	Unipolar		10		kΩ
	Bipolar		5		kΩ
	ADC ⁺ , ADC ⁻		Hi-Z		kΩ
Capacitance	CH0 to CH7, COM		5		pF
	Sample Mode ADC ⁺ , ADC ⁻ 0V to 2.048V, ±1.024V 0V to 4.096V, ±2.048V		24		pF
			12		pF
		Hold Mode ADC ⁺ , ADC ⁻		4	
Input Leakage Current	ADC ⁺ , ADC ⁻ , CONVST = Low			±1	μA

185789fb

LTC1857/LTC1858/LTC1859

DYNAMIC ACCURACY The ● denotes the specifications which apply over the full operating temperature range, otherwise specifications are at $T_A = 25^\circ\text{C}$. MUXOUT connected to ADC inputs. (Notes 5, 12)

SYMBOL	PARAMETER	CONDITIONS	LTC1857			LTC1858			LTC1859			UNITS
			MIN	TYP	MAX	MIN	TYP	MAX	MIN	TYP	MAX	
S/(N + D)	Signal-to-(Noise + Distortion) Ratio	1kHz Input Signal		74			83			87		dB
THD	Total Harmonic Distortion	1kHz Input Signal, First Five Harmonics		-101			-101			-101		dB
	Peak Harmonic or Spurious Noise	1kHz Input Signal		-103			-103			-103		dB
	Channel-to-Channel Isolation	1kHz Input Signal		-120			-120			-120		dB
	-3dB Input Bandwidth			1			1			1		MHz
	Aperture Delay			-70			-70			-70		ns
	Aperture Jitter			60			60			60		ps
	Transient Response	Full-Scale Step (Note 9)			4			4			4	μs
	Overvoltage Recovery	(Note 13)		150			150			150		ns

INTERNAL REFERENCE CHARACTERISTICS The ● denotes the specifications which apply over the full operating temperature range, otherwise specifications are at $T_A = 25^\circ\text{C}$. (Note 5)

PARAMETER	CONDITIONS	MIN	TYP	MAX	UNITS
V_{REF} Output Voltage	$I_{\text{OUT}} = 0$	● 2.475	2.5	2.525	V
V_{REF} Output Temperature Coefficient	$I_{\text{OUT}} = 0$		± 10		ppm/ $^\circ\text{C}$
V_{REF} Output Impedance	$-0.1\text{mA} \leq I_{\text{OUT}} \leq 0.1\text{mA}$		8		k Ω
V_{REFCOMP} Output Voltage	$I_{\text{OUT}} = 0$		4.096		V

DIGITAL INPUTS AND DIGITAL OUTPUTS The ● denotes the specifications which apply over the full operating temperature range, otherwise specifications are at $T_A = 25^\circ\text{C}$. (Note 5)

SYMBOL	PARAMETER	CONDITIONS	MIN	TYP	MAX	UNITS
V_{IH}	High Level Input Voltage	$V_{\text{DD}} = 5.25\text{V}$	● 2.4			V
V_{IL}	Low Level Input Voltage	$V_{\text{DD}} = 4.75\text{V}$			● 0.8	V
I_{IN}	Digital Input Current	$V_{\text{IN}} = 0\text{V to } V_{\text{DD}}$			● ± 10	μA
C_{IN}	Digital Input Capacitance			5		pF
V_{OH}	High Level Output Voltage	$V_{\text{DD}} = 4.75\text{V}, I_{\text{O}} = -10\mu\text{A}, \text{OV}_{\text{DD}} = V_{\text{DD}}$ $V_{\text{DD}} = 4.75\text{V}, I_{\text{O}} = -200\mu\text{A}, \text{OV}_{\text{DD}} = V_{\text{DD}}$	● 4	4.74		V V
V_{OL}	Low Level Output Voltage	$V_{\text{DD}} = 4.75\text{V}, I_{\text{O}} = 160\mu\text{A}, \text{OV}_{\text{DD}} = V_{\text{DD}}$ $V_{\text{DD}} = 4.75\text{V}, I_{\text{O}} = 1.6\text{mA}, \text{OV}_{\text{DD}} = V_{\text{DD}}$		0.05 ● 0.10	0.4	V V
I_{OZ}	Hi-Z Output Leakage	$V_{\text{OUT}} = 0\text{V to } V_{\text{DD}}, \text{RD} = \text{High}$			● ± 10	μA
C_{OZ}	Hi-Z Output Capacitance	$\text{RD} = \text{High}$		15		pF
I_{SOURCE}	Output Source Current	$V_{\text{OUT}} = 0\text{V}$		-10		mA
I_{SINK}	Output Sink Current	$V_{\text{OUT}} = V_{\text{DD}}$		10		mA

POWER REQUIREMENTS The ● denotes the specifications which apply over the full operating temperature range, otherwise specifications are at $T_A = 25^\circ\text{C}$. (Note 5)

PARAMETER	CONDITIONS	MIN	TYP	MAX	UNITS
Positive Supply Voltage	(Notes 9 and 10)	4.75	5	5.25	V
Positive Supply Current			● 8	13	mA
Nap Mode			5.5	8	mA
Sleep Mode	CONVST = 0V or 5V		8	15	μA
Power Dissipation			40		mW
Nap Mode			27.5		mW
Sleep Mode	CONVST = 0V or 5V		40		μW

185789fb

TIMING CHARACTERISTICS

The ● denotes the specifications which apply over the full operating temperature range, otherwise specifications are at $T_A = 25^\circ\text{C}$. (Note 5)

SYMBOL	PARAMETER	CONDITIONS	MIN	TYP	MAX	UNITS
$f_{\text{SAMPLE(MAX)}}$	Maximum Sampling Frequency	Through CH0 to CH7 Inputs Through ADC ⁺ , ADC ⁻ Only	● 100	166		kHz kHz
t_{CONV}	Conversion Time		●	4	5	μs
t_{ACQ}	Acquisition Time	Through CH0 to CH7 Inputs Through ADC ⁺ , ADC ⁻ Only	●	1	4	μs μs
f_{SCK}	SCK Frequency	(Note 14)	● 0		20	MHz
t_r	SDO Rise Time	See Test Circuits		6		ns
t_f	SDO Fall Time	See Test Circuits		6		ns
t_1	CONVST High Time		● 40			ns
t_2	CONVST to $\overline{\text{BUSY}}$ Delay	$C_L = 25\text{pF}$, See Test Circuits	●	15	30	ns
t_3	SCK Period		● 50			ns
t_4	SCK High		● 10			ns
t_5	SCK Low		● 10			ns
t_6	Delay Time, SCK \downarrow to SDO Valid	$C_L = 25\text{pF}$, See Test Circuits	●	25	45	ns
t_7	Time from Previous SDO Data Remains Valid After SCK \downarrow	$C_L = 25\text{pF}$, See Test Circuits	●	5	20	ns
t_8	SDO Valid After $\overline{\text{RD}}\downarrow$	$C_L = 25\text{pF}$, See Test Circuits	●	11	30	ns
t_9	$\overline{\text{RD}}\downarrow$ to SCK Setup Time		● 20			ns
t_{10}	SDI Setup Time Before SCK \uparrow		● 0			ns
t_{11}	SDI Hold Time After SCK \uparrow		● 7			ns
t_{12}	SDO Valid Before $\overline{\text{BUSY}}\uparrow$	$\overline{\text{RD}} = \text{Low}$, $C_L = 25\text{pF}$, See Test Circuits	●	5	20	ns
t_{13}	Bus Relinquish Time	See Test Circuits	●	10	30	ns

Note 1: Stresses beyond those listed under Absolute Maximum Ratings may cause permanent damage to the device. Exposure to any Absolute Maximum Rating condition for extended periods may affect device reliability and lifetime.

Note 2: All voltage values are with respect to ground with DGND, AGND1, AGND2 and AGND3 wired together unless otherwise noted.

Note 3: When these pin voltages are taken below ground or above $AV_{\text{DD}} = DV_{\text{DD}} = OV_{\text{DD}} = V_{\text{DD}}$, they will be clamped by internal diodes. This product can handle currents of greater than 100mA below ground or above V_{DD} without latching.

Note 4: When these pin voltages are taken below ground they will be clamped by internal diodes. This product can handle currents of greater than 100mA below ground without latching. These pins are not clamped to V_{DD} .

Note 5: $V_{\text{DD}} = 5\text{V}$, $f_{\text{SAMPLE}} = 100\text{kHz}$, $t_r = t_f = 5\text{ns}$ unless otherwise specified.

Note 6: Linearity, offset and full-scale specifications apply for a single-ended analog MUX input with respect to ground or ADC⁺ with respect to ADC⁻ tied to ground.

Note 7: Integral nonlinearity is defined as the deviation of a code from a straight line passing through the actual end points of the transfer curve. The deviation is measured from the center of the quantization band.

Note 8: Bipolar zero error is the offset voltage measured from -0.5LSB when the output code flickers between 0000 0000 0000 0000 and 1111 1111 1111 1111 for the LTC1859, between 00 0000 0000 0000 and 11 1111 1111 1111 for the LTC1858 and between 0000 0000 0000 and 1111 1111 1111 for the LTC1857. Unipolar zero error is the offset voltage measured from 0.5LSB when the output codes flicker between 0000 0000 0000 0000 and 0000 0000 0000 0001 for the LTC1859, between 00 0000 0000 0000 and 00 0000 0000 0001 for the LTC1858 and between 0000 0000 0000 0000 and 0000 0000 0001 for the LTC1857.

Note 9: Guaranteed by design, not subject to test.

Note 10: Recommended operating conditions.

Note 11: Full-scale bipolar error is the worst case of $-FS$ or $+FS$ untrimmed deviation from ideal first and last code transitions, divided by the full-scale range, and includes the effect of offset error. For unipolar full-scale error, the deviation of the last code transition from ideal, divided by the full-scale range, and includes the effect of offset error.

Note 12: All Specifications in dB are referred to a full-scale $\pm 10\text{V}$ input.

Note 13: Recovers to specified performance after $(2 \cdot FS)$ input overvoltage.

Note 14: t_6 of 45ns maximum allows f_{SCK} up to 10MHz for rising capture with 50% duty cycle and f_{SCK} up to 20MHz for falling capture (with 5ns setup time for the receiving logic).

Note 15: The specification is referred to the $\pm 10\text{V}$ input range.

TYPICAL PERFORMANCE CHARACTERISTICS

LTC1859 Typical INL Curve

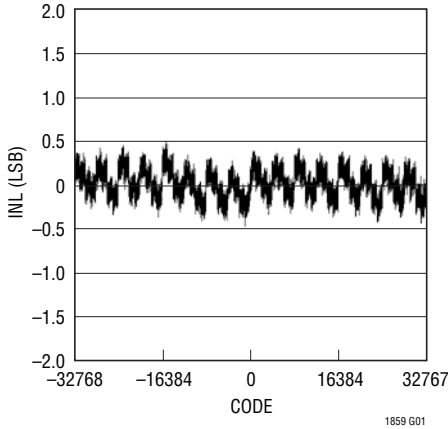

LTC1859 Typical DNL Curve

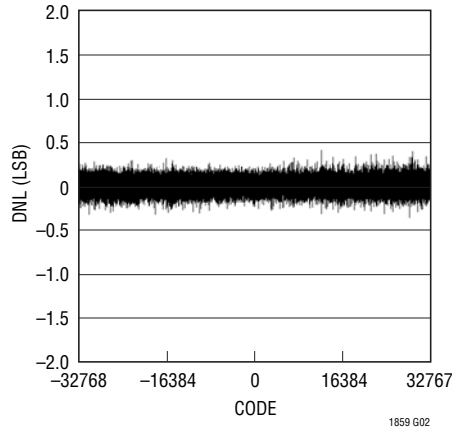

LTC1859 Nonaveraged 4096-Point FFT Plot

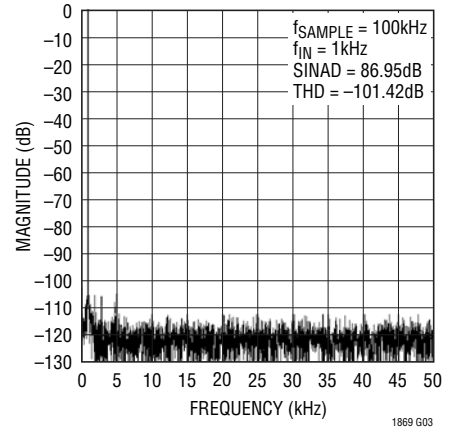

LTC1859 SINAD vs Input Frequency

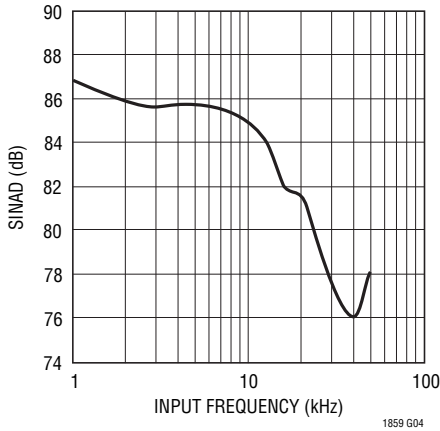

LTC1859 Total Harmonic Distortion vs Input Frequency

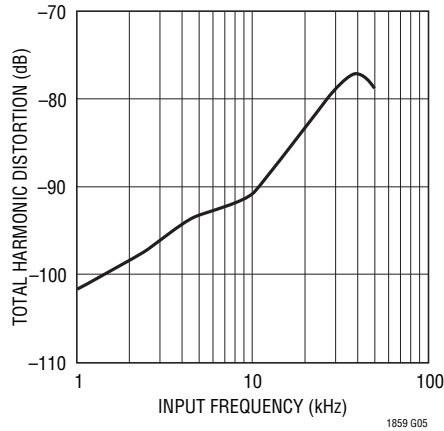

LTC1859 Channel-to-Channel Offset Error Matching vs Temperature

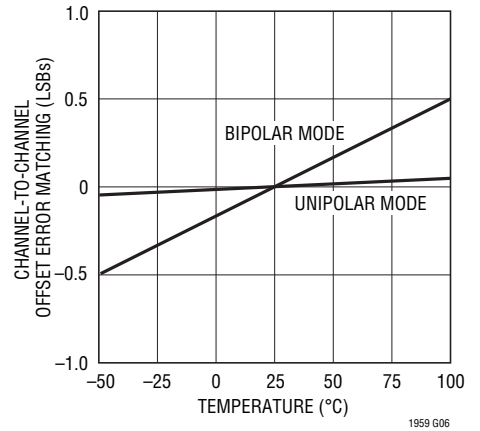

LTC1859 Channel-to-Channel Gain Error Matching vs Temperature

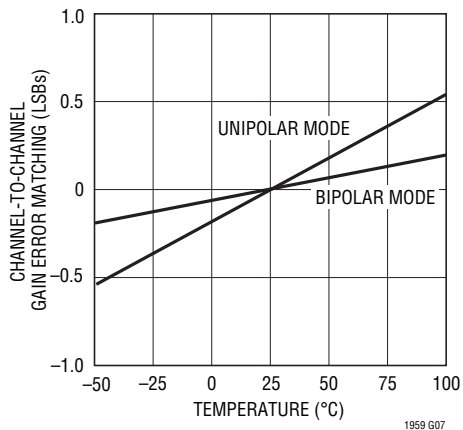

Internal Reference Voltage vs Temperature

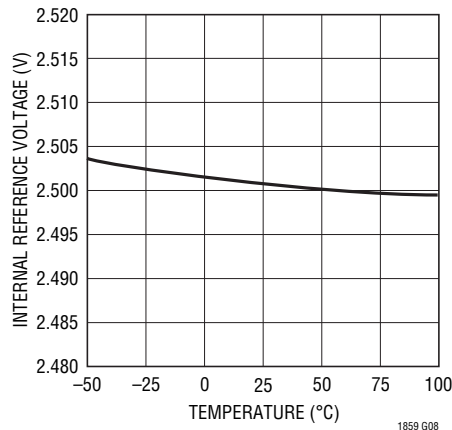

Change in REFCOMP Voltage vs Load Current

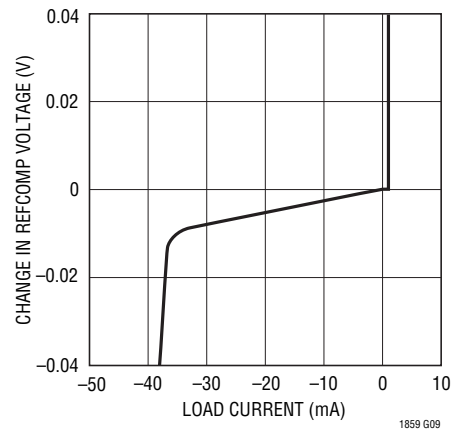

TYPICAL PERFORMANCE CHARACTERISTICS

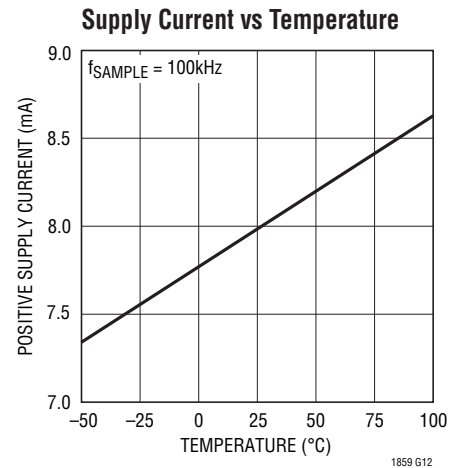
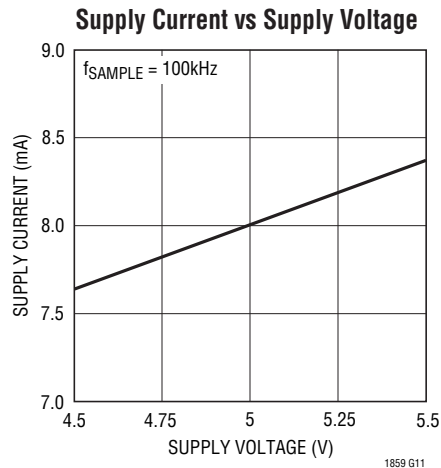
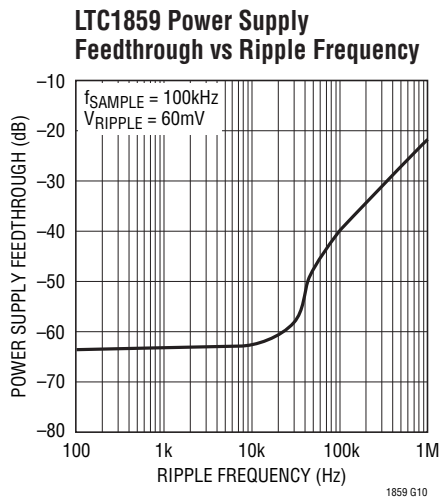

PIN FUNCTIONS

COM (Pin 1): Common Input. This is the reference point for all single-ended inputs. It must be free of noise and is usually connected to the analog ground plane.

CH0 (Pin 2): Analog MUX Input.

CH1 (Pin 3): Analog MUX Input.

CH2 (Pin 4): Analog MUX Input.

CH3 (Pin 5): Analog MUX Input.

CH4 (Pin 6): Analog MUX Input.

CH5 (Pin 7): Analog MUX Input.

CH6 (Pin 8): Analog MUX Input.

CH7 (Pin 9): Analog MUX Input.

MUXOUT⁺ (Pin 10): Positive MUX Output. Output of the analog multiplexer. Connect to ADC⁺ for normal operation.

MUXOUT⁻ (Pin 11): Negative MUX Output. Output of the analog multiplexer. Connect to ADC⁻ for normal operation.

ADC⁺ (Pin 12): Positive Analog Input to the Analog-to-Digital Converter.

ADC⁻ (Pin 13): Negative Analog Input to the Analog-to-Digital Converter.

AGND1 (Pin 14): Analog Ground.

V_{REF} (Pin 15): 2.5V Reference Output. Bypass to analog ground with a 1 μ F tantalum capacitor.

REFCOMP (Pin 16): Reference Buffer Output. Bypass to analog ground with a 10 μ F tantalum and a 0.1 μ F ceramic capacitor. Nominal output voltage is 4.096V.

AGND2 (Pin 17): Analog Ground.

AGND3 (Pin 18): Analog Ground. This is the substrate connection.

AV_{DD} (Pin 19): 5V Analog Supply. Bypass to analog ground with a 0.1 μ F ceramic and a 10 μ F tantalum capacitor.

DV_{DD} (Pin 20): 5V Digital Supply. Bypass to digital ground with a 0.1 μ F ceramic and a 10 μ F tantalum capacitor.

OV_{DD} (Pin 21): Positive Supply for the Digital Output Buffers (3V to 5V). Bypass to digital ground with a 0.1 μ F ceramic and a 10 μ F tantalum capacitor.

BUSY (Pin 22): Output shows converter status. It is low when a conversion is in progress.

SDO (Pin 23): Serial Data Output.

PIN FUNCTIONS

DGND (Pin 24): Digital Ground.

SDI (Pin 25): Serial Data Input. SDI will ignore clocked data while \overline{RD} is high.

SCK (Pin 26): Serial Data Clock.

\overline{RD} (Pin 27): Read Input. This active low signal enables the digital output pin SDO.

CONVST (Pin 28): Conversion Start. This active high signal starts a conversion on its rising edge.

FUNCTIONAL BLOCK DIAGRAM

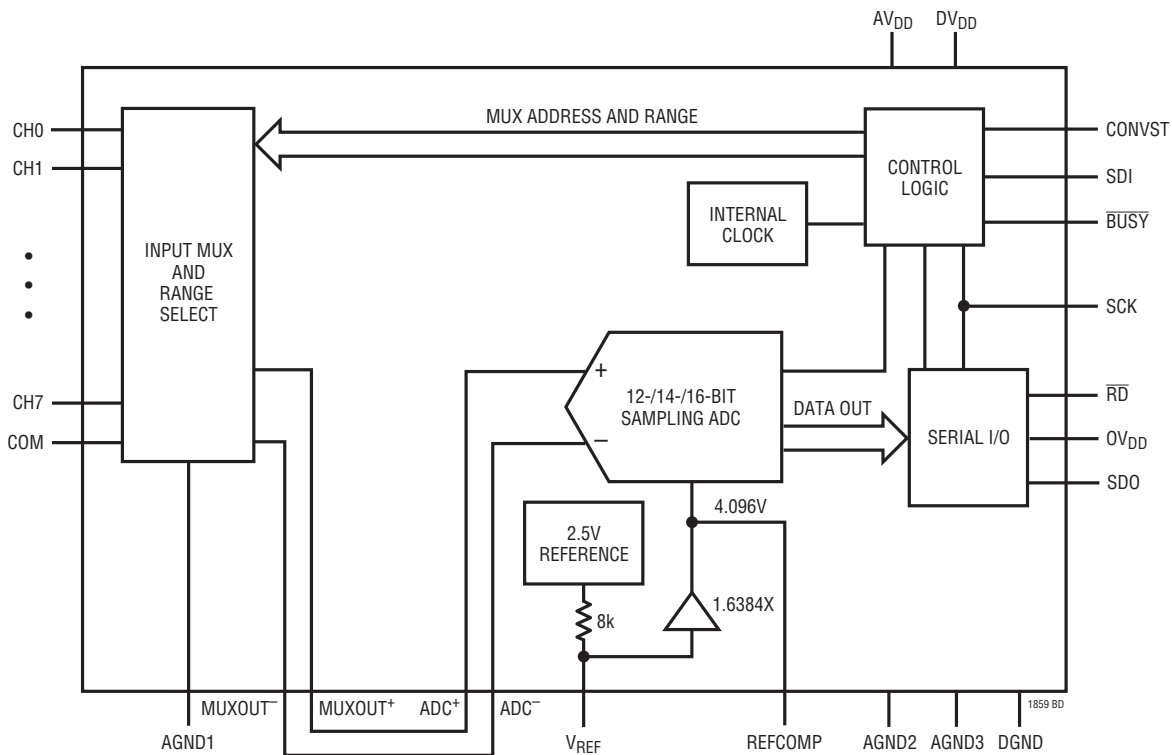

TEST CIRCUITS

Load Circuits for Access Timing

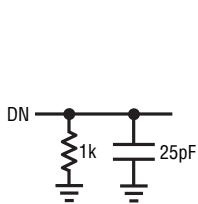

(A) Hi-Z to V_{OH} AND V_{OL} TO V_{OH}

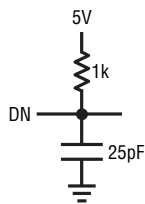

(B) Hi-Z to V_{OL} AND V_{OH} TO V_{OL}

1859 TC01

Load Circuits for Output Float Delay

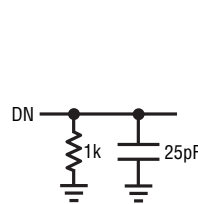

(A) V_{OH} TO Hi-Z

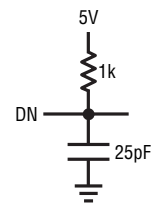

(B) V_{OL} TO Hi-Z

1859 TC02

TIMING DIAGRAMS

t₁ (For Short Pulse Mode)

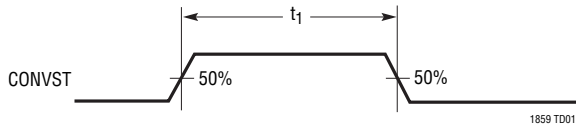

t₂ (CONVST to $\overline{\text{BUSY}}$ Delay)

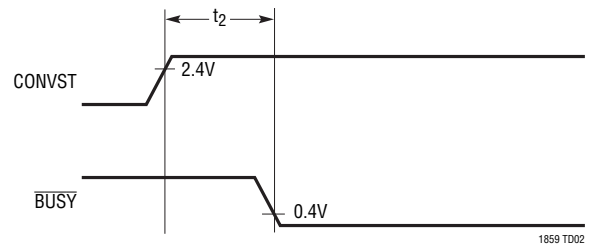

**t₆ (Delay Time, SCK↓ to SDO Valid)
t₇ (Time from Previous Data Remains Valid After SCK↓)**

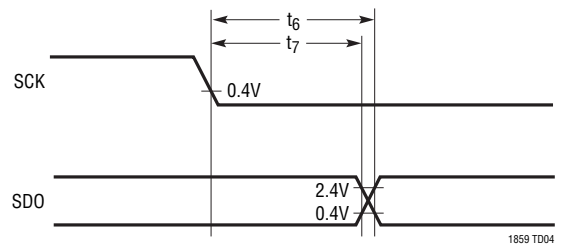

t₃, t₄, t₅ (SCK Timing)

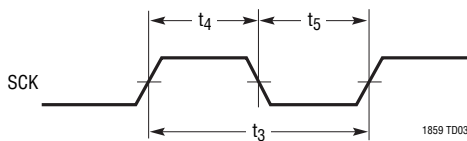

t₈ (SDO Valid After $\overline{\text{RD}}\downarrow$)

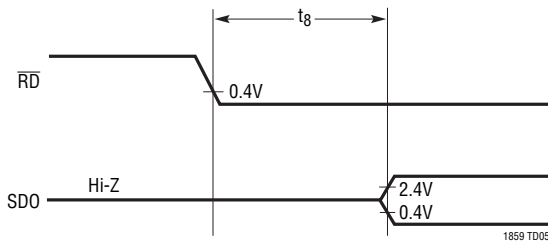

t₉ ($\overline{\text{RD}}\downarrow$ to SCK Setup Time)

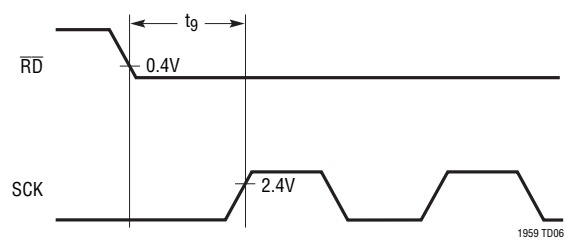

t₁₀ (SDI Setup Time Before SCK↑)

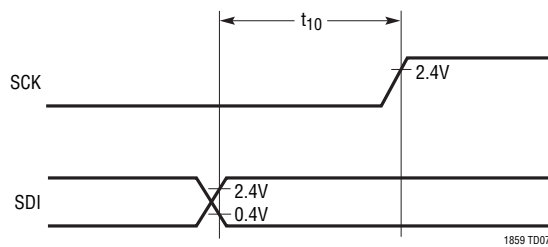

t₁₁ (SDI Hold Time After SCK↑)

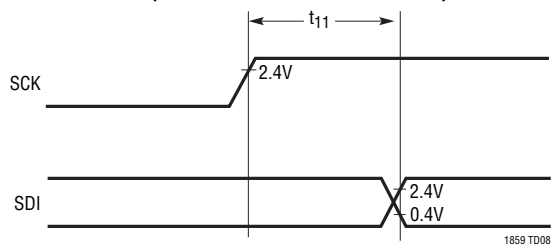

t₁₂ (SDO Valid Before $\overline{\text{BUSY}}\uparrow$, $\overline{\text{RD}} = 0$)

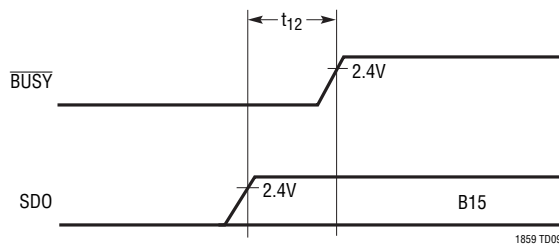

t₁₃ (BUS Relinquish Time)

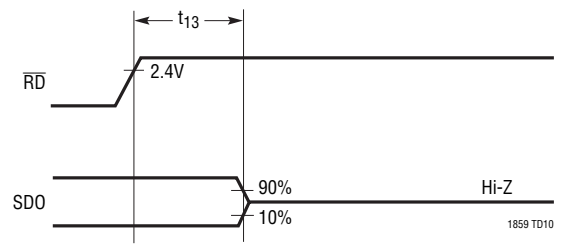

OPERATION

OVERVIEW

The LTC1857/LTC1858/LTC1859 are innovative, multichannel ADCs that provide software-selectable input ranges for each of their eight input channels. Using on-chip resistors and switches, it provides an attenuation and offset that can be programmed for each channel on the fly. The precisely trimmed attenuators ensure accurate input ranges. Because they precede the multiplexer, errors due to multiplexer on-resistance are eliminated.

The input word that selects the input channel also selects the desired input range for that channel. The available ranges are 0V to 5V, 0V to 10V (unipolar), $\pm 5V$ and $\pm 10V$ (bipolar). They are achieved with the ADC running on a single 5V supply. In addition to the range selection, single-ended or differential inputs may be selected for each channel or pair of channels. Finally, overrange protection is provided for unselected channels. An overrange condition on an unused channel will not affect the conversion result on the selected channel.

CONVERSION DETAILS

The LTC1857/LTC1858/LTC1859 use a successive approximation algorithm and an internal sample-and-hold circuit to convert an analog signal to a 12-/14-/16-bit serial output respectively. The ADCs are complete with a precision reference and an internal clock. The control logic provides easy interface to microprocessors and DSPs. (Please refer to the Digital Interface section for the data format.)

The analog signals applied at the MUX input channels are rescaled by the resistor divider network formed by R1, R2 and R3 as shown below. The rescaled signals appear on the MUXOUT (Pins 10, 11) which are also connected to the ADC inputs (Pins 12, 13) under normal operation.

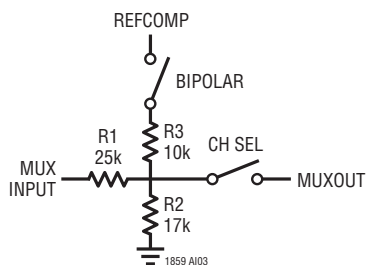

Before starting a conversion, an 8-bit data word is clocked into the SDI input on the first eight rising SCK edges to select the MUX address, input range and power down mode. The ADC enters acquisition mode on the falling edge of the sixth clock in the 8-bit data word and ends on the rising edge of the CONVST signal which also starts a conversion (see Figure 7). A minimum time of 4 μ s will provide enough time for the sample-and-hold capacitors to acquire the analog signal. Once a conversion cycle has begun, it cannot be restarted.

During the conversion, the internal differential 12-/14-/16-bit capacitive DAC output is sequenced by the SAR from the most significant bit (MSB) to the least significant bit (LSB). The input is successively compared with the binary weighted charges supplied by the differential capacitive DAC. Bit decisions are made by a high speed comparator. At the end of a conversion, the DAC output balances the analog input ($ADC^+ - ADC^-$). The SAR contents (a 16-bit data word) which represents the difference of ADC^+ and ADC^- are loaded into the 12-/14-/16-bit shift register.

DRIVING THE ANALOG INPUTS

The nominal input ranges for the LTC1857/LTC1858/LTC1859 are 0V to 5V, 0V to 10V, $\pm 5V$ and $\pm 10V$ and the MUX inputs are overvoltage protected to $\pm 25V$. The input impedance is typically 42k Ω in unipolar mode and 31k Ω in bipolar mode, therefore, it should be driven with a low impedance source. Wideband noise coupling into the input can be minimized by placing a 3000pF capacitor at the input as shown in Figure 2. An NPO-type capacitor gives the lowest distortion. Place the capacitor as close to the device input pin as possible. If an amplifier is to be used to drive the input, care should be taken to select an amplifier with adequate accuracy, linearity and noise for the application. The following list is a summary of the op amps that are suitable for driving the LTC1857/LTC1858/LTC1859. More detailed information is available in the Linear Technology data books and online at www.linear.com.

LT[®]1007: Low noise precision amplifier. 2.7mA supply current $\pm 5V$ to $\pm 15V$ supplies. Gain bandwidth product 8MHz. DC applications.

APPLICATIONS INFORMATION

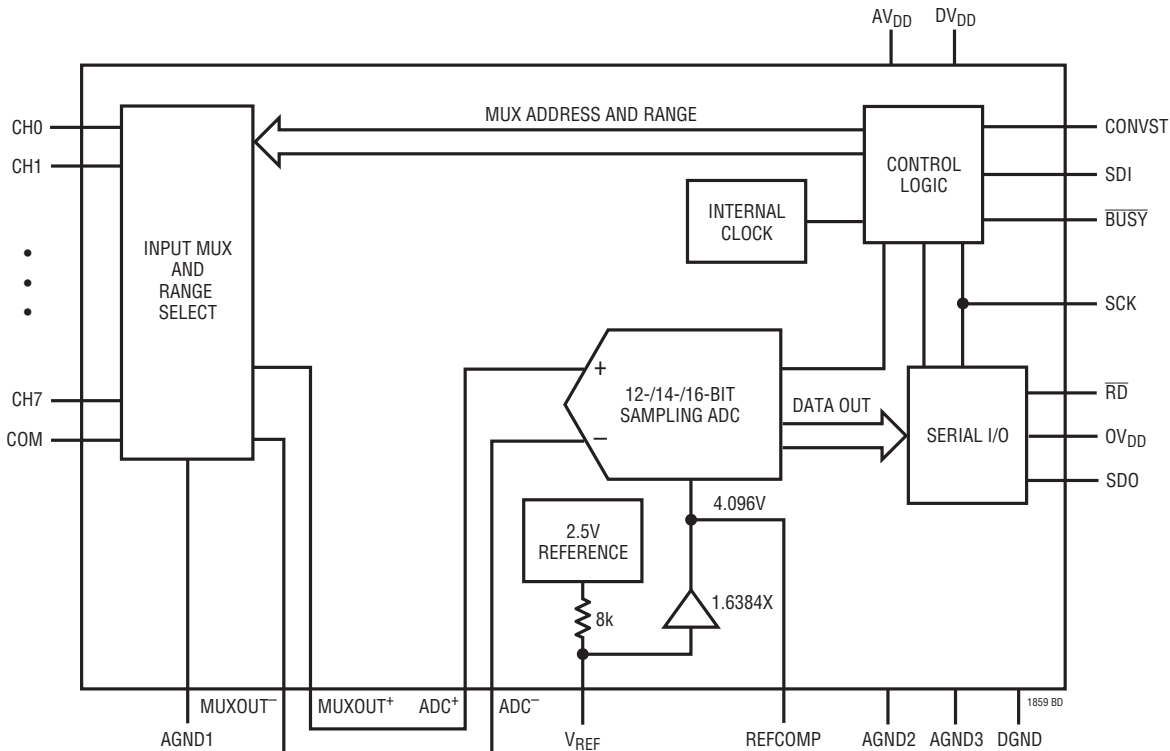

Figure 1. LTC1857/LTC1858/LTC1859 Simplified Equivalent Circuit

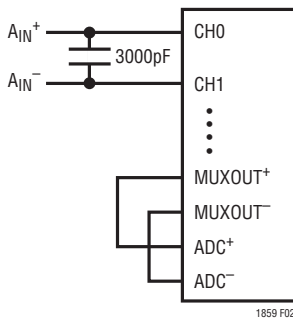

Figure 2. Analog Input Filtering

LT1227: 140MHz video current feedback amplifier. 10mA supply current. $\pm 5V$ to $\pm 15V$ supplies. Low noise and low distortion.

LT1468/LT1469: Single and dual 90MHz, 16-bit accurate op amp. Good AC/DC specs.

LT1677: Single, low noise op amp. Rail-to-rail input and output. Up to $\pm 15V$ supplies.

LT1792: Single, low noise JFET input op amp, $\pm 5V$ supplies.

LT1793: Single, low noise JFET input op amp, 10pA bias current, $\pm 5V$ supplies.

LT1881/LT1882: Dual and quad, 200pA bias current, rail-to-rail output op amps. Up to $\pm 15V$ supplies.

LT1844/LT1885: Dual and quad, 400pA bias current, rail-to-rail output op amps. Up to $\pm 15V$ supplies. Faster response and settling time.

INTERNAL VOLTAGE REFERENCE

The LTC1857/LTC1858/LTC1859 have an on-chip, temperature compensated, curvature corrected, bandgap reference, which is factory trimmed to 2.50V. The full-scale range of the LTC1857/LTC1858/LTC1859 is equal to $\pm 5V$, 0V to 5V, $\pm 10V$ or 0V to 10V. The output of the reference is connected to the input of a gain of 1.6384x buffer through an 8k resistor (see Figure 3). The input to the buffer or

APPLICATIONS INFORMATION

the output of the reference is available at V_{REF} (Pin 15). The internal reference can be overdriven with an external reference if more accuracy is needed. The buffer output drives the internal DAC and is available at REFCOMP (Pin 16). The REFCOMP pin can be used to drive a steady DC load of less than 2mA. Driving an AC load is not recommended because it can cause the performance of the converter to degrade.

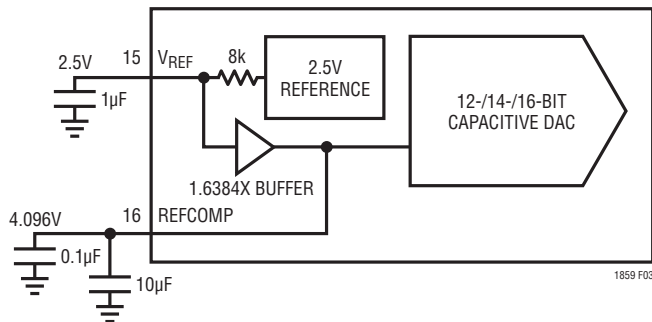

Figure 3. Internal or External Reference Source

For minimum code transition noise the V_{REF} pin and the REFCOMP pin should each be decoupled with a capacitor to filter wideband noise from the reference and the buffer.

UNIPOLAR / BIPOLAR OPERATION

Figure 4a shows the ideal input/output characteristics for the LTC1859. The code transitions occur midway

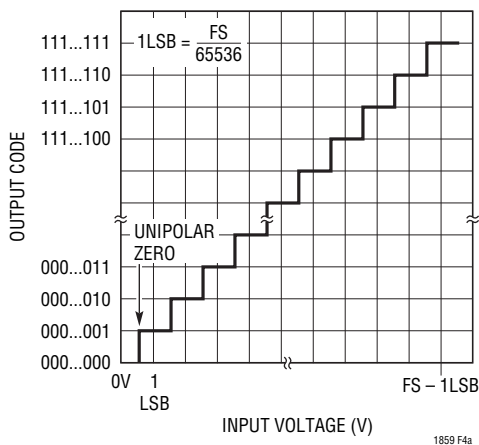

Figure 4a. Unipolar Transfer Characteristics (UNI = 1)

between successive integer LSB values (i.e., 0.5LSB, 1.5LSB, 2.5LSB, ... $FS - 1.5LSB$). The output code is natural binary with $1LSB = FS/65536$. Figure 4b shows the input/output transfer characteristics for the bipolar mode in two's complement format.

FULL SCALE AND OFFSET

In applications where absolute accuracy is important, offset and full-scale errors can be adjusted to zero during a calibration sequence. Offset error must be adjusted before full-scale error. Zero offset is achieved by adjusting the offset applied to the “-” input. For single-ended inputs, this offset should be applied to the COM pin. For differential inputs, the “-” input is dictated by the MUX address. For unipolar zero offset error, apply 0.5LSB (actual voltage will vary with input span selected) to the “+” input and adjust the offset at the “-” input until the output code flickers between 0000 0000 0000 0000 and 0000 0000 0000 0001 for the LTC1859, between 00 0000 0000 0000 and 00 0000 0000 0001 for the LTC1858 and between 0000 0000 0000 and 0000 0000 0001 for the LTC1857.

For bipolar zero error, apply $-0.5LSB$ (actual voltage will vary with input span selected) to the “+” input and adjust the offset at the “-” input until the output code flickers between 0000 0000 0000 0000 and 1111 1111 1111 1111 for the LTC1859, between 00 0000 0000 0000 and

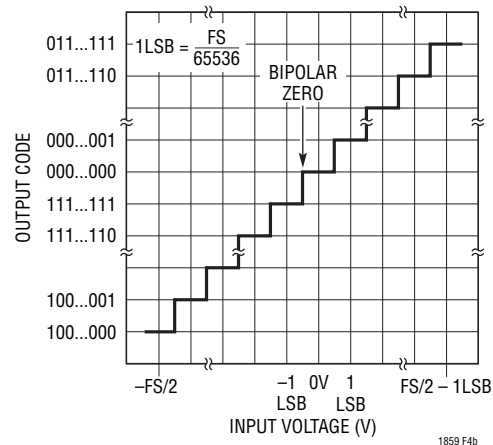

Figure 4b. Bipolar Transfer Characteristics (UNI = 0)

APPLICATIONS INFORMATION

11 1111 1111 1111 for the LTC1858 and between 0000 0000 0000 and 1111 1111 1111 for the LTC1857.

As mentioned earlier, the internal reference is factory trimmed to 2.50V. To make sure that the reference buffer gain is not compensating for trim errors in the reference, REFCOMP is trimmed with an accurate external 2.5V reference applied to V_{REF} . For unipolar inputs, an input voltage of FS – 1.5LSBs should be applied to the “+” input and the appropriate reference adjusted until the output code flickers between 1111 1111 1111 1110 and 1111 1111 1111 1111 for the LTC1859, between 11 1111 1111 1110 and 11 1111 1111 1111 for the LTC1858 and between 1111 1111 1110 and 1111 1111 1111 for the LTC1857.

For bipolar inputs, an input voltage of FS – 1.5LSBs should be applied to the “+” input and the appropriate reference adjusted until the output code flickers between 0111 1111 1111 1110 and 0111 1111 1111 1111 for the LTC1859, between 01 1111 1111 1110 and 01 1111 1111 1111 for the LTC1858 and between 0111 1111 1110 and 0111 1111 1111 for the LTC1857.

These adjustments as well as the factory trims affect all channels. The channel-to-channel offset and gain error matching are guaranteed by design to meet the specifications in the Converter Characteristics table.

DC PERFORMANCE

One way of measuring the transition noise associated with a high resolution ADC is to use a technique where a DC signal is applied to the input of the MUX and the resulting output codes are collected over a large number of conversions. For example in Figure 5 the distribution of output code is shown for a DC input that has been digitized 4096 times. The distribution is Gaussian and the RMS code transition is about 1LSB for the LTC1859.

DIGITAL INTERFACE

Internal Clock

The ADC has an internal clock that is trimmed to achieve a typical conversion time of 4 μ s. No external adjustments are required and, with the maximum acquisition time of 4 μ s, throughput performance of 100ksps is assured.

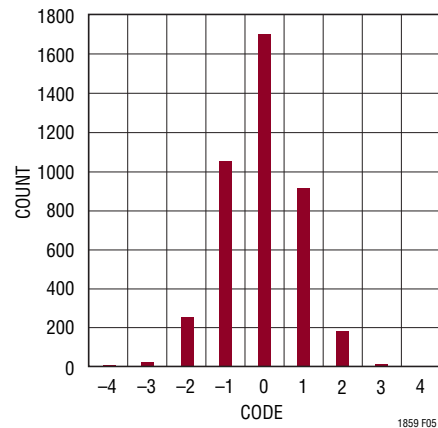

Figure 5. LTC1859 Histogram for 4096 Conversions

3V Input/Output Compatible

The LTC1857/LTC1858/LTC1859 operate on a 5V supply, which makes the devices easy to interface to 5V digital systems. These devices can also interface to 3V digital systems: the digital input pins (SCK, SDI, CONVST and \overline{RD}) of the LTC1857/LTC1858/LTC1859 recognize 3V or 5V inputs. The LTC1857/LTC1858/LTC1859 have a dedicated output supply pin (OVP) that controls the output swings of the digital output pins (SDO, \overline{BUSY}) and allows the part to interface to either 3V or 5V digital systems. The output is two's complement binary for bipolar mode and offset binary for unipolar mode.

Timing and Control

Conversion start and data read are controlled by two digital inputs: CONVST and \overline{RD} . To start a conversion and put the sample-and-hold into the hold mode bring CONVST high for no less than 40ns. Once initiated it cannot be re-started until the conversion is complete. Converter status is indicated by the \overline{BUSY} output and this is low while the conversion is in progress.

Figures 6a and 6b show two different modes of operation for the LTC1859. For the 12-bit LTC1857 and 14-bit LTC1858, the last four and two bits of the SDO will output zeros respectively. In mode 1 (Figure 6a), \overline{RD} is tied low. The rising edge of CONVST starts the conversion. The data outputs are always enabled. The MSB of the data output is available after the conversion. In mode 2 (Figure 6b), CONVST and \overline{RD} are tied together. The rising edge of the CONVST signal starts the conversion. Data outputs are in

185789fb

APPLICATIONS INFORMATION

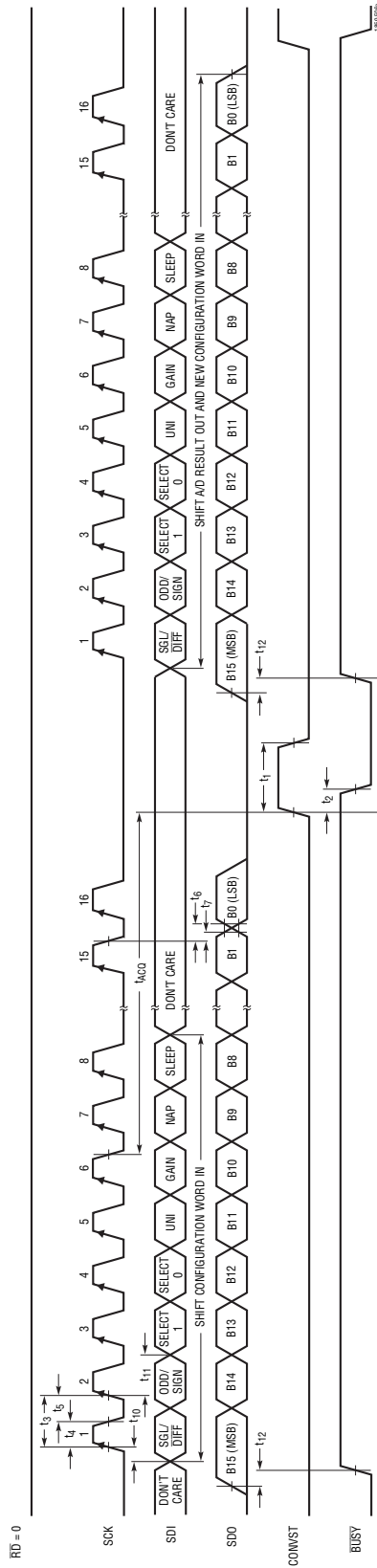

Figure 6a. Mode 1 for the LTC1859*. CONVST Starts a Conversion, Data Output is Always Enabled (RD = 0)

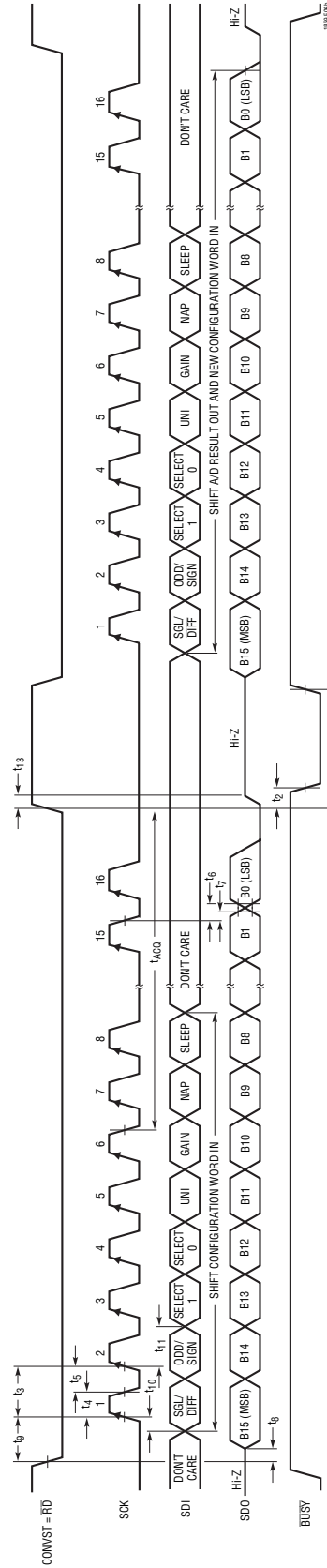

Figure 6b. Mode 2 for the LTC1859*. CONVST and RD Tied Together. CONVST Starts a Conversion, Data is Read by RD

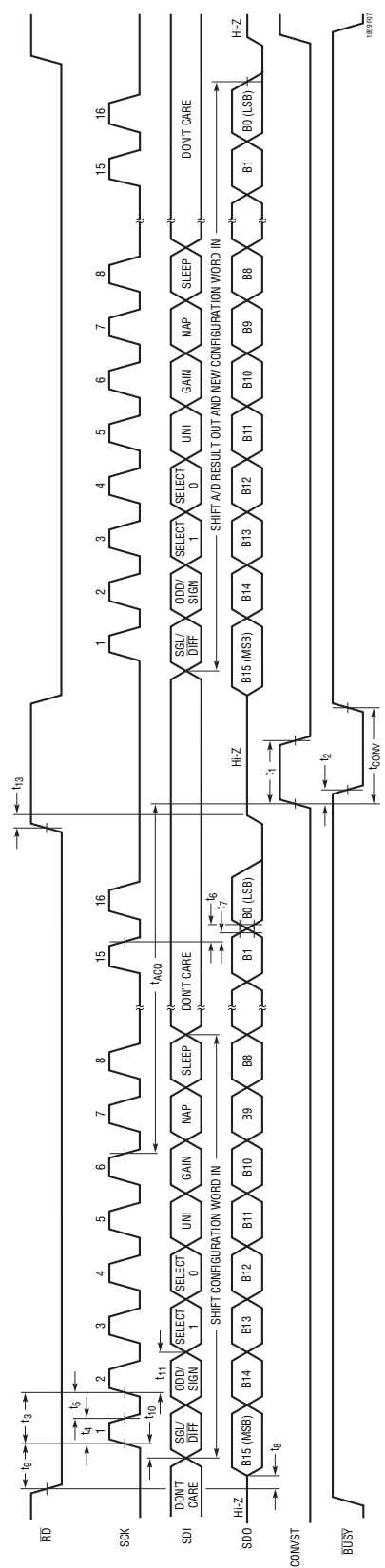

Figure 7. Operating Sequence for the LTC1859*

*For the 12-bit LTC1857 and 14-bit LTC1858, the last four and two bits of the SDO will output zeros respectively.

APPLICATIONS INFORMATION

three-state at this time. When the conversion is complete ($\overline{\text{BUSY}}$ goes high), CONVST and $\overline{\text{RD}}$ go low to enable the data output for the previous conversion.

SERIAL DATA INPUT (SDI) INTERFACE

The LTC1857/LTC1858/LTC1859 communicate with micro-processors and other external circuitry via a synchronous, full duplex, 3-wire serial interface (see Figure 7). The shift clock (SCK) synchronizes the data transfer with each bit being transmitted on the falling SCK edge and captured on the rising SCK edge in both transmitting and receiving systems. The data is transmitted and received simultaneously (full duplex).

An 8-bit input word is shifted into the SDI input which configures the LTC1857/LTC1858/LTC1859 for the next conversion. Simultaneously, the result of the previous conversion is output on the SDO line. At the end of the data exchange the requested conversion begins by applying a rising edge on CONVST . After t_{CONV} , the conversion is complete and the results will be available on the

next data transfer cycle. As shown below, the result of a conversion is delayed by one conversion from the input word requesting it.

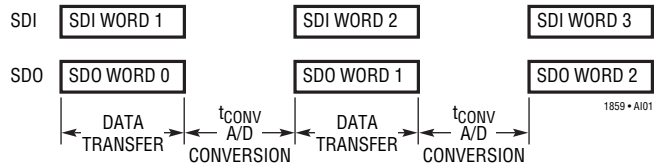

INPUT DATA WORD

The LTC1857/LTC1858/LTC1859 8-bit data word is clocked into the SDI input on the first eight rising SCK edges. Further inputs on the SDI pin are then ignored until the next conversion. The eight bits of the input word are defined as follows:

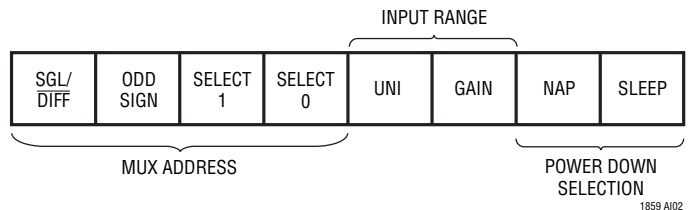

Table 1. Multiplexer Channel Selection

MUX ADDRESS			DIFFERENTIAL CHANNEL SELECTION							MUX ADDRESS			SINGLE-ENDED CHANNEL SELECTION										
SGL/DIFF	ODD SIGN	SELECT 1 0	0	1	2	3	4	5	6	7	SGL/DIFF	ODD SIGN	SELECT 1 0	0	1	2	3	4	5	6	7	COM	
0	0	0 0	+	-							1	0	0 0	+									-
0	0	0 1			+	-					1	0	0 1			+							-
0	0	1 0					+	-			1	0	1 0					+					-
0	0	1 1							+	-	1	0	1 1							+			-
0	1	0 0	-	+							1	1	0 0		+								-
0	1	0 1			-	+					1	1	0 1				+						-
0	1	1 0					-	+			1	1	1 0					+					-
0	1	1 1							-	+	1	1	1 1								+		-

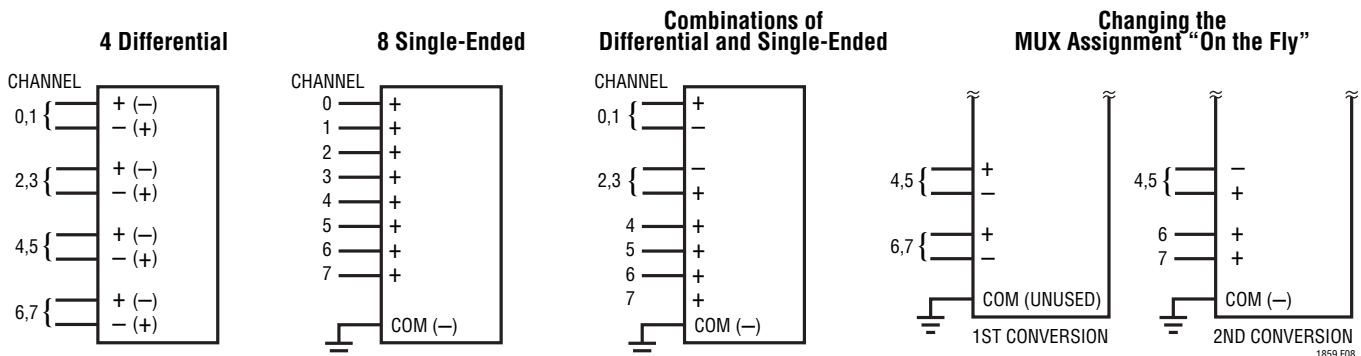

Figure 8. Examples of Multiplexer Options on the LTC1857/LTC1858/LTC1859

APPLICATIONS INFORMATION

MUX ADDRESS

The first four bits of the input word assign the MUX configuration for the requested conversion. For a given channel selection, the converter will measure the voltage between the two channels indicated by the + and – signs in the selected row of Table 1. Note that in differential mode ($SGL/DIFF = 0$) measurements are limited to four adjacent input pairs with either polarity. In single-ended mode, all input channels are measured with respect to COM. Both the “+” and “–” inputs are sampled simultaneously so common mode noise is rejected.

INPUT RANGE (UNI, GAIN)

The fifth and sixth input bits (UNI, GAIN) determine the input range for the conversion. When UNI is a logical one, a unipolar conversion will be performed. When UNI is a logical zero, a bipolar conversion will result. The GAIN input bit determines the input span for the conversion. When GAIN is a logical one, either 0V to 10V or $\pm 10V$ input spans will be selected depending on UNI. When GAIN is a logical zero, either 0V to 5V or $\pm 5V$ input spans will be chosen. The input ranges for different UNI and GAIN inputs are shown in Table 2.

Table 2. Input Range Selection

UNI	GAIN	INPUT RANGE
0	0	$\pm 5V$
1	0	0V to 5V
0	1	$\pm 10V$
1	1	0V to 10V

POWER DOWN SELECTION (NAP, SLEEP)

The last two bits of the input word (Nap and Sleep) determine the power shutdown mode of the LTC1857/LTC1858/LTC1859. See Table 3. Nap mode is selected when Nap = 1 and Sleep = 0. The previous conversion result will be clocked out and a conversion will occur before entering the Nap mode. The Nap mode starts at the end of the

conversion which is indicated by the rising edge of the \overline{BUSY} signal. Nap mode lasts until the falling edge of the 2nd SCK (see Figure 9). Automatic nap will be achieved if Nap = 1 is selected each time an input word is written to the ADC.

Table 3. Power Down Selection

NAP	SLEEP	POWER DOWN MODE
0	0	Power On
1	0	Nap
X	1	Sleep

Sleep mode will occur when Sleep = 1 is selected, regardless of the selection of the Nap input. The previous conversion result can be clocked out and the Sleep mode will start on the falling edge of the last (16th) SCK. Notice that the CONVST should stay either high or low in sleep mode (see Figure 10). To wake up from the sleep mode, apply a rising edge on the CONVST signal and then apply Sleep = 0 on the next SDI word and the part will wake up on the falling edge of the last (16th) SCK (see Figure 11).

In Sleep mode, all bias currents are shut down and only the power on reset circuit and leakage currents (about 10 μ A) remain. Sleep mode wake-up time is dependent on the value of the capacitor connected to the REFCOMP (Pin 16). The wake-up time is typically 40ms with the recommended 10 μ F capacitor connected on the REFCOMP pin.

DYNAMIC PERFORMANCE

FFT (Fast Fourier Transform) test techniques are used to test the ADC's frequency response, distortion and noise at the rated throughput. By applying a low distortion sine wave and analyzing the digital output using an FFT algorithm, the ADC's spectral content can be examined for frequencies outside the fundamental. Figure 12 shows a typical LTC1859 FFT plot which yields a SINAD of 87dB and THD of $-101dB$.

APPLICATIONS INFORMATION

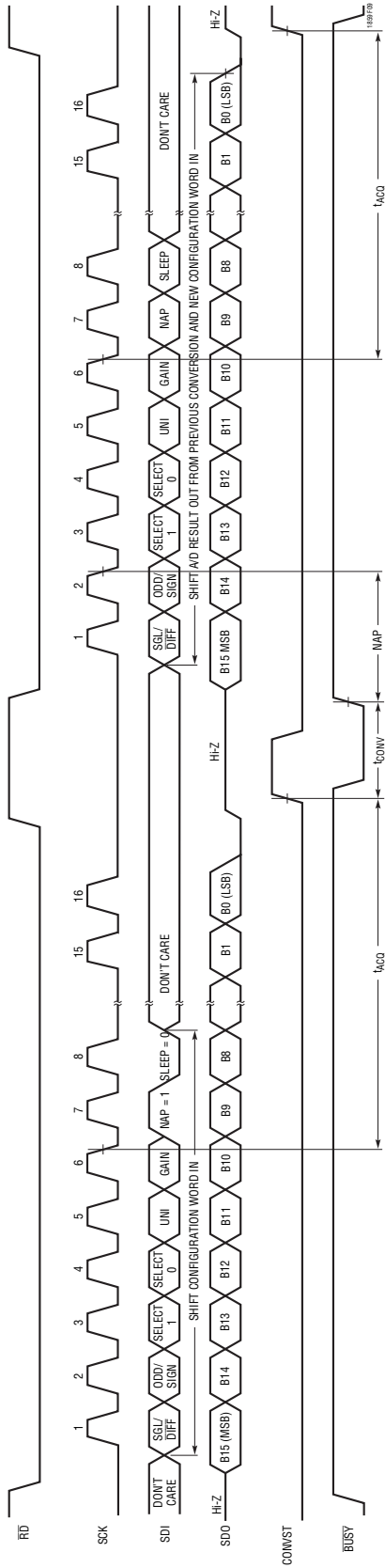

Figure 9. Nap Mode Operation for the LTC1859*

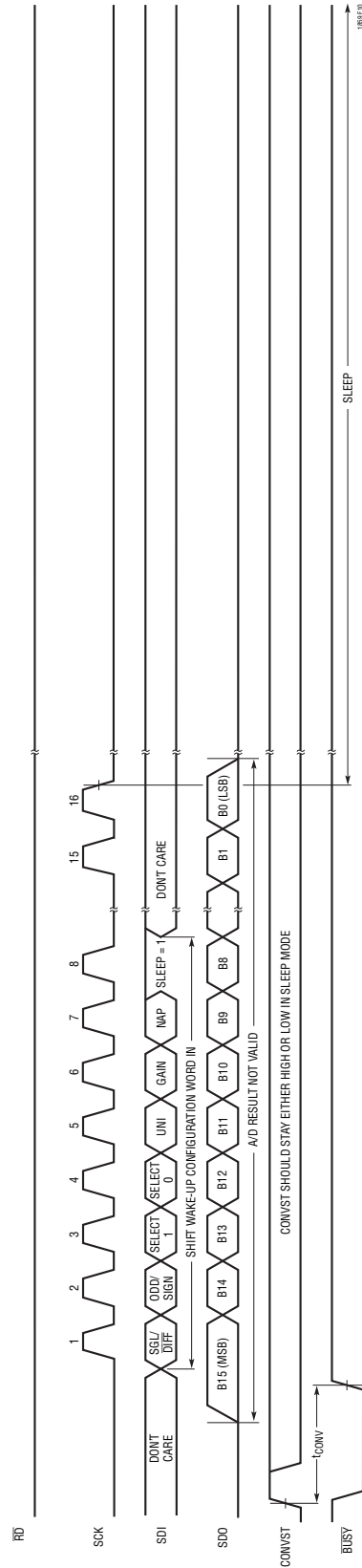

Figure 10. Sleep Mode Operation for the LTC1859*

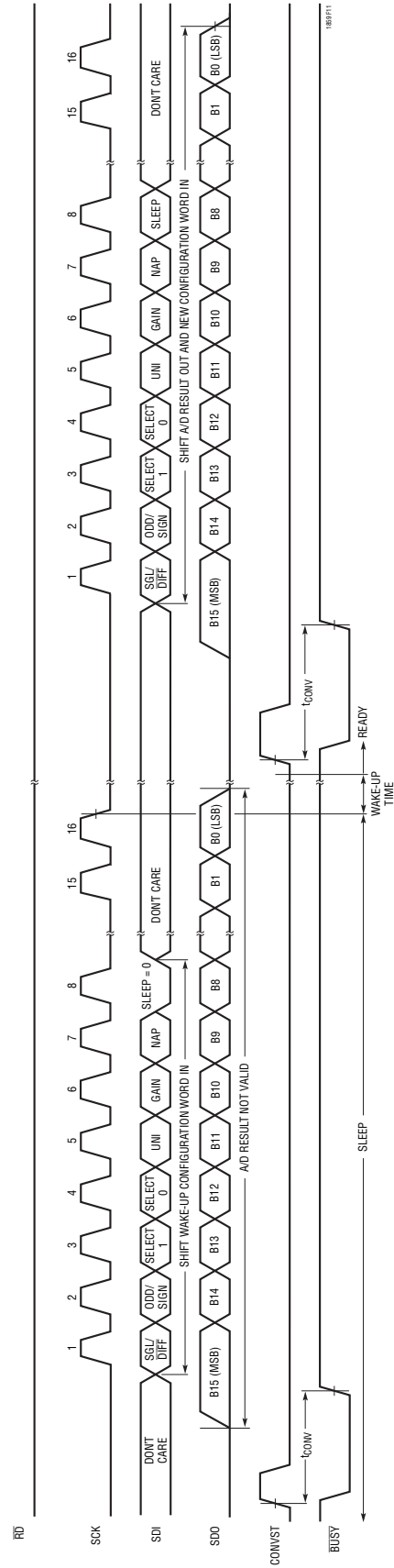

Figure 11. Wake Up from Sleep Mode for the LTC1859*

*For the 12-bit LTC1857 and 14-bit LTC1858, the last four and two bits of the SDO will output zeros respectively.

APPLICATIONS INFORMATION

SIGNAL-TO-NOISE RATIO

The Signal-to-Noise and Distortion Ratio (SINAD) is the ratio between the RMS amplitude of the fundamental input frequency to the RMS amplitude of all other frequency components at the A/D output. The output is band limited to frequencies from above DC and below half the sampling frequency. Figure 12 shows a typical SINAD of 87dB with a 100kHz sampling rate and a 1kHz input.

TOTAL HARMONIC DISTORTION

Total Harmonic Distortion (THD) is the ratio of the RMS sum of all harmonics of the input signal to the fundamental itself. The out-of-band harmonics alias into the frequency band between DC and half the sampling frequency. THD is expressed as:

$$\text{THD} = 20 \log \frac{\sqrt{V_2^2 + V_3^2 + V_4^2 \dots + V_N^2}}{V_1}$$

where V_1 is the RMS amplitude of the fundamental frequency and V_2 through V_N are the amplitudes of the second through Nth harmonics.

BOARD LAYOUT, POWER SUPPLIES AND DECOUPLING

Wire wrap boards are not recommended for high resolution or high speed A/D converters. To obtain the best performance from the LTC1857/LTC1858/LTC1859, a printed circuit board is required. Layout for the printed circuit board should ensure the digital and analog signal lines are separated as much as possible. In particular, care should be taken not to run any digital track alongside an analog signal track or underneath the ADC. The analog input should be screened by AGND.

In applications where the MUX is connected to the ADC, it is possible to get noise coupling into the ADC from the trace connecting the MUXOUT to the ADC. Therefore, reducing the length of the traces connecting the MUXOUT pins (Pins 10, 11) to the ADC pins (Pins 12, 13) can minimize the problem. The unused MUX inputs should be grounded to prevent noise coupling into the inputs.

Figure 13 shows the power supply grounding that will help obtain the best performance from the 12-bit/14-bit/16-bit ADCs. Pay particular attention to the design of the analog and digital ground planes. The DGND pin of the LTC1857/

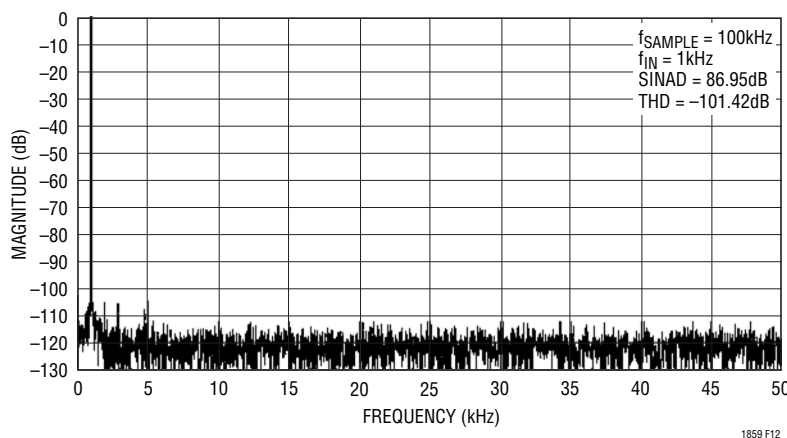

Figure 12. LTC1859 Nonaveraged 4096 Point FFT Plot

APPLICATIONS INFORMATION

LTC1858/LTC1859 can be tied to the analog ground plane. Placing the bypass capacitor as close as possible to the power supply pins, the reference and reference buffer output is very important. Low impedance common returns for these bypass capacitors are essential to low noise operation of the ADC, and the foil width for these tracks should be as wide as possible. Also, since any potential difference in

grounds between the signal source and ADC appears as an error voltage in series with the input signal, attention should be paid to reducing the ground circuit impedance as much as possible. The digital output latches and the onboard sampling clock have been placed on the digital ground plane. The two ground planes are tied together at the power supply ground connection.

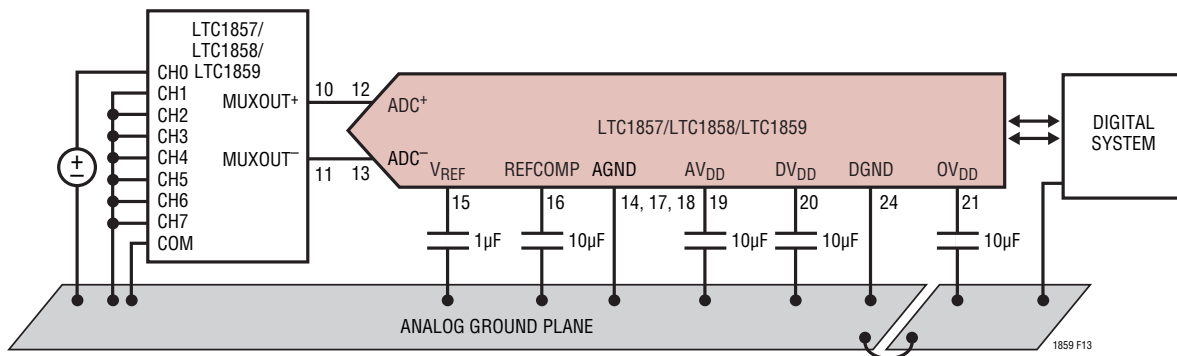
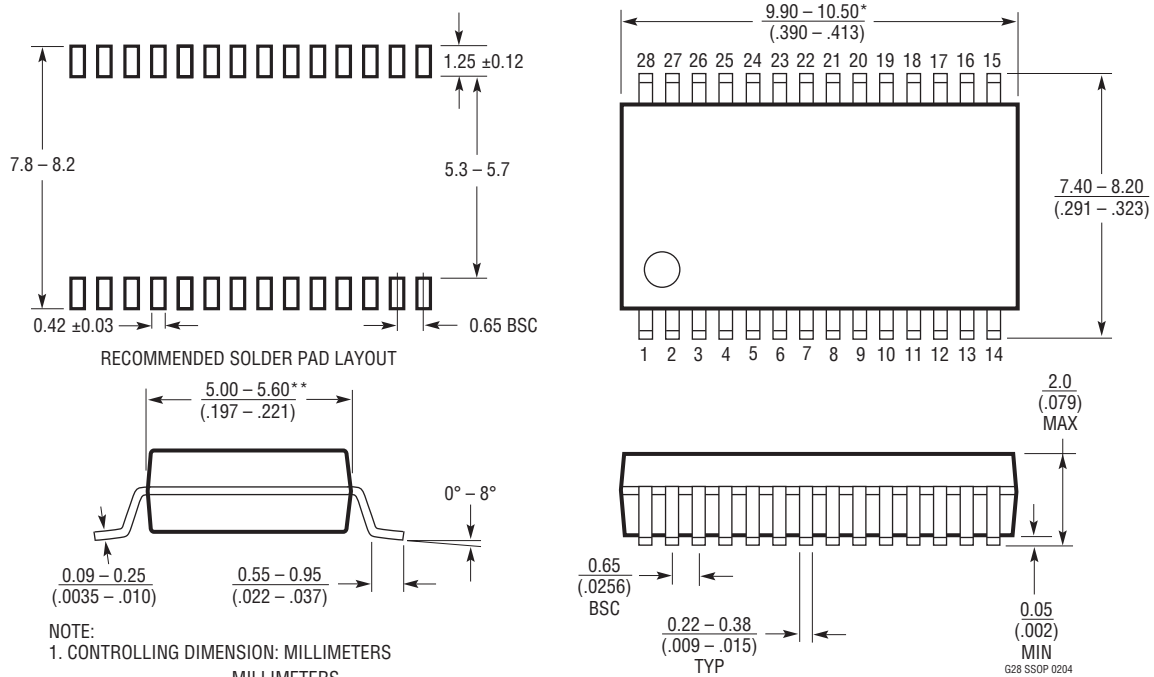

Figure 13. Power Supply Grounding Practice

PACKAGE DESCRIPTION

Please refer to <http://www.linear.com/designtools/packaging/> for the most recent package drawings.

G Package 28-Lead Plastic SSOP (5.3mm) (Reference LTC DWG # 05-08-1640)



NOTE:

1. CONTROLLING DIMENSION: MILLIMETERS
 2. DIMENSIONS ARE IN $\frac{\text{MILLIMETERS}}{\text{(INCHES)}}$
 3. DRAWING NOT TO SCALE
- *DIMENSIONS DO NOT INCLUDE MOLD FLASH. MOLD FLASH SHALL NOT EXCEED .152mm (.006") PER SIDE
- **DIMENSIONS DO NOT INCLUDE INTERLEAD FLASH. INTERLEAD FLASH SHALL NOT EXCEED .254mm (.010") PER SIDE

G28 SSOP 0204

REVISION HISTORY (Revision history begins at Rev B)

REV	DATE	DESCRIPTION	PAGE NUMBER
B	06/15	Added part marking. Updated SDI pin functionality description.	2 8

LTC1857/LTC1858/LTC1859

TYPICAL APPLICATION

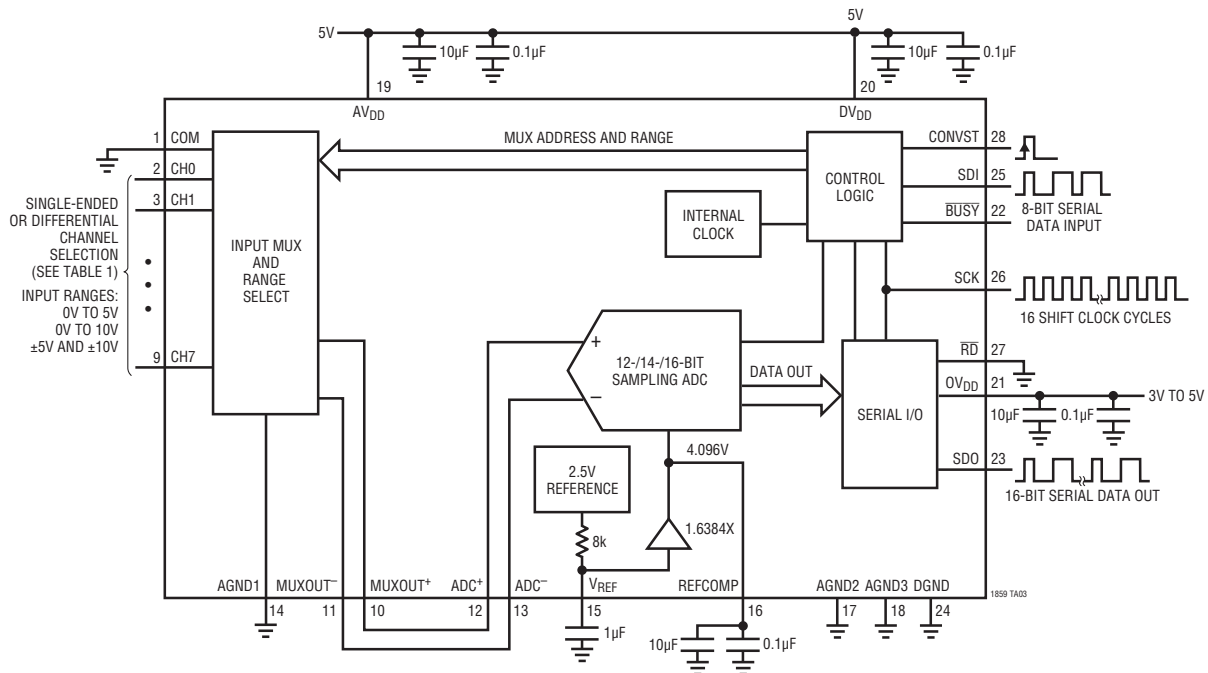

RELATED PARTS

PART NUMBER	DESCRIPTION	COMMENTS
Sampling ADCs		
LTC1417	14-Bit, 400ksps Serial ADC	5V or ±5V, 20mW, 81dB SINAD and -95dB THD
LTC1418	14-Bit, 200ksps, Single 5V or ±5V ADC	15mW, Serial/Parallel I/O
LTC1604	16-Bit, 333ksps, ±5V ADC	90dB SINAD, 220mW Power Dissipation, Pin Compatible with LTC1608
LTC1605	16-Bit, 100ksps, Single 5V ADC	±10V Inputs, 55mW, Byte or Parallel I/O, Pin Compatible with LTC1606
LTC1606	16-Bit, 250ksps, Single 5V ADC	±10V Inputs, 75mW, Byte or Parallel I/O, Pin Compatible with LTC1605
LTC1608	16-Bit, 500ksps, ±5V ADC	90dB SINAD, 270mW Power Dissipation, Pin Compatible with LTC1604
LTC1609	16-Bit, 200ksps Serial ADC	Configurable Unipolar/Bipolar Input, Single 5V Supply
LTC1850/LTC1851	10-Bit/12-Bit, 8-Channel, 1.25Msps ADC	Programmable MUX and Sequencer, Parallel I/O
LTC1852/LTC1853	10-Bit/12-Bit, 8-Channel, 400ksps ADC	Single 3V-5V, Programmable MUX and Sequencer, Parallel I/O
LTC1864/LTC1865	16-Bit, 1-/2-Channel, 250ksps ADC in MSOP	Single 5V Supply, 850µA with Autoshtutdown
LTC1864L/LTC1865L	3V, 16-Bit, 1-/2-Channel, 150ksps ADC in MSOP	Single 3V Supply, 450µA with Autoshtutdown
DACs		
LTC1588/LTC1589/LTC1592	12-/14-/16-Bit, Serial, SoftSpan I _{OUT} DACs	Software-Selectable Spans, ±1LSB INL/DNL
LTC1595	16-Bit Serial Multiplying I _{OUT} DAC in SO-8	±1LSB Max INL/DNL, Low Glitch, DAC8043 16-Bit Upgrade
LTC1596	16-Bit Serial Multiplying I _{OUT} DAC	±1LSB Max INL/DNL, Low Glitch, AD7543/DAC8143 16-Bit Upgrade
LTC1597	16-Bit Parallel, Multiplying DAC	±1LSB Max INL/DNL, Low Glitch, 4 Quadrant Resistors
LTC1650	16-Bit Serial V _{OUT} DAC	Low Power, Low Gritch, 4-Quadrant Multiplication
Op Amps		
LT1468/LT1469	Single/Dual 90MHz, 22V/µs, 16-Bit Accurate Op Amp	Low Input Offset : 75µV/125µV

185789fb